

GRAVITY SEWER

MEETS ASTM D3034 AND ASTM F679



*Building essentials
for a better tomorrow™*



GRAVITY SEWER

ASTM D3034

SDR 35 and SDR 26

Ring-Tite™ Joints 4"-15"

ASTM F679

PS46 and PS115

Ring-Tite™ Joints 18"-36"

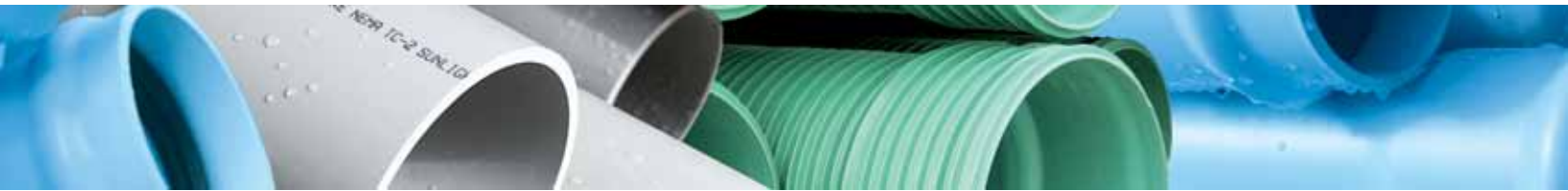

GRAVITY SEWER

CONTENTS

01	PRODUCT DESCRIPTION	2
02	SHORT FORM SPECIFICATION	5
03	DIMENSIONS AND WEIGHTS	6
04	FLOW/DISCHARGE CHARTS	8
05	EXTERNAL LOADS	10
06	DEFLECTION AND TESTING	13
07	INSTALLATION.	17
08	FITTINGS AND ADAPTORS	24
09	SHORT FORM INSTALLATION GUIDE	25
10	WARRANTY	26

01

PRODUCT DESCRIPTION

GRAVITY SEWER PIPE AND FITTINGS

DESCRIPTION

JM Eagle™ realizes the growing demand for an effective all-out attack on water pollution, highlighting the need for improved sanitary sewage collection systems. A modern system needs pipe with improved design for reserve strength and stiffness to increase load-bearing capacity—all within the framework of maximizing sewer system capacity at a reasonable cost. JM Eagle's Ring-Tite™ PVC sewer pipe is designed to meet this need.

LONG LAYING LENGTHS

The standard laying lengths of Ring-Tite™ PVC Sewer Pipe are 14 and/or 20 feet. This means that more ground can be covered during installation while eliminating the cost of unnecessary joints.



APPLICATIONS

JM Eagle's Ring-Tite™ PVC sewer pipe is suitable for conveying domestic sanitary sewage as well as certain industrial wastes. For further information regarding the suitability of PVC for conveying various chemicals, call our Product Assurance Department at (800) 621-4404.

QUALITY CONTROL

This pipe is tested in accordance with the provisions of ASTM D3034 and ASTM F679 and subject to inspection by our quality control inspectors throughout every step of the manufacturing process.

JM Eagle's Quality Management System is ISO 9001:2000 registered.* Copies of the registration certificates are available on our website at <http://www.jmeagle.com>.

* JM Eagle™ is in the process of obtaining the ISO 9001-2000 registration of Quality Management System for all locations.



CORROSION RESISTANCE

JM Eagle's Ring-Tite™ PVC sewer pipe is unaffected by the fluids found in ordinary domestic sewage. It is immune to sewer gases and the sulfuric acid generated by the completion of the hydrogen sulfide cycle. It is also immune to corrosive soils—both alkaline or acidic.

ABRASION RESISTANCE

JM Eagle's Ring-Tite™ PVC sewer pipe has excellent resistance to abrasion, gouging and scouring, superior to that of most common piping materials.

FLOW CAPACITY

This PVC sewer pipe's long laying lengths, smooth interior, and factory-made close tolerance joints, provides a Manning "N" coefficient of .009. High-carrying capacity makes the use of flatter grades or smaller diameter pipe possible.

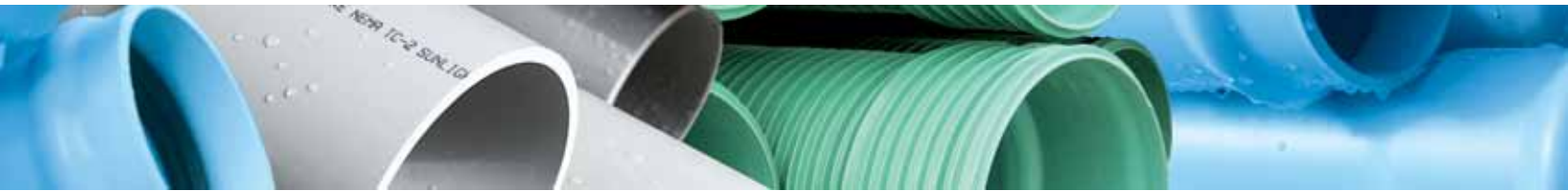

SAVE IN HANDLING COSTS

JM Eagle's Ring-Tite™ PVC Sewer pipe is designed for installed-cost savings. Most sizes can be handled manually, so there is no need for costly installation equipment. Use the backhoe for excavating and backfilling only. Dig more trench, lay pipe faster, and save more in cost per foot installed.

FIELD CUTTING AND BEVELING

You can cut Ring-Tite™ PVC sewer pipe with a power saw or an ordinary handsaw. This eliminates the need to invest in costly cutting equipment. The pipe can also be beveled without the use of any expensive or complicated machinery.

LIGHT WEIGHT

A 14 foot length of 8" SDR 35 Ring-Tite™ PVC sewer pipe weighs approximately 55 pounds. That makes it easy to load, easy to transport, and easy to handle. Installers prefer it because it goes into the ground quickly—thus saving on installation costs.



SERVICE LIFE

Since PVC does not corrode and is resistant to most chemicals, this pipe does not lose strength due to either sewer gas corrosion or external galvanic soil conditions. The design of the pipe allows for a long-term deflection of 7.5%, without failure or damage.

INSTALLATION

This product should be installed in accordance with JM Eagle™ Publication JME-05B, "Gravity Sewer Installation Guide."

GRAVITY SEWER O.D.

Available in 4" through 36" diameter sizes, this pipe can be connected directly to most existing sewer equipment. It can also be connected into I.P.S., cast/ductile iron pipe and fittings with adapters and/or transition gaskets.





PRODUCT DESCRIPTION

(CONTINUED)

RING-TITE™ JOINTS WITH LOCKED-IN GASKETS

JM Eagle's Ring-Tite™ joint can be assembled quickly. Seated in a deep groove, the flexible elastomeric Rieber®* gasket provides a tight seal that protects the line from shock, vibration, earth movement, and compensates for expansion and contraction of pipe lengths. There's no field mixing or application of cement. It's a simple push together joint that remains tight under normal operating conditions.

The factory installed Rieber® gaskets provide a tight, flexible seal, that resists rolling during installation. Special gasket types are available for use with certain chemical and petroleum products. Spigot pipe ends are supplied from the factory with bevels. The bell is an integral part of the pipe length with the same strength. Joints meet or exceed ASTM D3212 for joint tightness, including a 22 in. Hg vacuum and a 25 feet of Head Pressure test.

Note: Other types of gaskets may be provided. JM Eagle™ is in the process of converting all gasketed products to the Rieber® ring gasket.

* Rieber® is a registered trademark of TI Specialty Products Inc.

RING-TITE™ JOINT

"Locked - in" Rieber® gasket provides tight, flexible seal. Meets requirements of ASTM D3212-Joints for Drain and Sewer Pipes using Flexible Elastomeric Seals.

Spigot pipe ends are supplied from factory with bevels.

The bell is an integral part of the pipe length with the same strength.

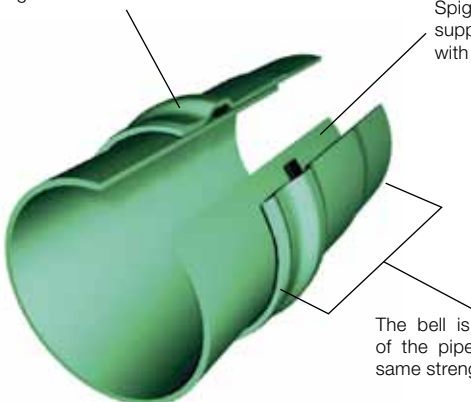

ACCESSORIES

JM Eagle's Ring-Tite™ PVC sewer pipe is compatible with all the items required for smooth installation of sewer and industrial waste pipelines.



SHORT FORM SPECIFICATION

GRAVITY SEWER PIPE AND FITTINGS

SCOPE

This specification designates general requirements for 4" through 36" unplasticized polyvinyl chloride (PVC) plastic Gravity Sewer pipe with integral bell and spigot joints for the conveyance of domestic sanitary sewage as well as certain industrial wastes.

MATERIALS

All pipe and fittings shall meet the requirements of ASTM D3034 for 4" through 15" SDR 35/26 and F679 for 18" through 36" 46PS/115PS sewer pipe. The pipe shall be colored green for in-ground identification as sewer pipe. All pipe shall be made from quality PVC resin, compounded to provide physical and mechanical properties that equal or exceed cell class 12454 or 12364 as defined in ASTM D1784.

LONG LAYING LENGTHS

Standard laying lengths shall be 14 feet and/or 20 feet for all sizes.

PIPE

All pipe shall be suitable for use as a gravity sewer conduit. Provisions must be made for expansion and contraction at each joint with an elastomeric gasket. The bell shall consist of an integral wall section with a solid cross section Rieber® elastomeric gasket which meets the requirements of ASTM F477. Gaskets are factory assembled and securely locked in place to prevent displacement during assembly. The joint design shall meet requirements of ASTM D3212 under both pressure and 22 in. Hg vacuum. Size and dimensions shall be as shown in this specification.

Pipe installation and usage shall be in compliance with the JM Eagle™ Publication JME-05B, "Gravity Sewer Installation Guide."

FITTINGS

All fittings and accessories shall be as manufactured and furnished by the pipe supplier or approved equal and have bell and/or spigot configurations compatible with that of the pipe.

PIPE STIFFNESS

Minimum "pipe stiffness" (F/Δy) at 5% deflection shall be 46 psi for SDR 35 and 115 psi for SDR 26 for all sizes when tested in accordance with ASTM D2412, "External Loading Properties of Plastic Pipe by Parallel-Plate Loading."

DROP IMPACT TEST

A 6" length section of pipe shall be subjected to impact from a free falling tup (20-lb Tup A and flat plate holder B for 4"-15", and 20-lb or 30-lb Tup B and flat plate holder B for 18"-36") in accordance with ASTM D2444.

PIPE SIZE (IN)	IMPACT (FT/LBS)
4	150
6 - 8	210
10 - 36	220

There shall be no visible evidence of shattering or splitting when the energy is imposed.

JOINT TIGHTNESS

Two sections of pipe shall be assembled in accordance with the manufacturer's recommendations. Joint shall be tested in accordance with ASTM D3212, "Joints for Drain and Sewer Plastic Pipe Using Flexible Elastomeric Seals" under 25 feet of Head Pressure and 22 in. Hg vacuum.

FLATTENING

There shall be no evidence of splitting, cracking, or breaking when the pipe is tested as follows:

Flatten specimen of pipe, six inches long between parallel plates in a suitable press until the distance between the plates is forty percent of the outside diameter of the pipe. The rate of loading shall be uniform and such that the compression is completed within two to five minutes.

INSTALLATION

Product should be installed in accordance with JM Eagle™ Publication JME-05B, "Gravity Sewer Installation Guide."

03

DIMENSIONS AND WEIGHTS

SUBMITTAL AND DATA SHEET

PIPE SIZE (IN)	AVERAGE O.D. (IN)	NOM. I.D. (IN)	MIN. T. (IN)	MIN. E (IN)	APPROX. D ⁹ (IN)	APPROX. WEIGHT (LBS/FT)
SDR 35 (PS46) ASTM D3034						
4	4.215	3.975	0.120	3.50	4.695	1.05
6	6.275	5.915	0.180	4.25	6.995	2.36
8	8.400	7.920	0.240	4.75	9.360	4.24
10	10.500	9.900	0.300	6.00	11.700	6.64
12	12.500	11.780	0.360	6.25	13.940	9.50
15	15.300	14.426	0.437	7.25	17.048	14.19
SDR 26 (PS115) ASTM D3034						
4	4.215	3.891	0.162	3.50	4.863	1.40
6	6.275	5.793	0.241	4.25	7.239	3.11
8	8.400	7.754	0.323	4.75	9.692	5.63
10	10.500	9.692	0.404	6.00	12.116	8.84
12	12.500	11.538	0.481	6.25	14.424	12.56
15	15.300	14.124	0.588	7.25	17.652	18.90
PS46, ASTM F679						
18	18.701	17.629	0.499	8.00	20.845	21.43
21	22.047	20.783	0.588	9.50	24.575	29.88
24	24.803	23.381	0.661	9.60	27.647	38.96
27	27.953	26.351	0.745	10.10	31.157	49.47
30 CIOD	32.000	30.194	0.853	16.75	35.612	64.18
36 CIOD	38.300	36.042	1.021	19.02	42.816	93.00
42 CIOD	44.500	41.948	1.187	22.43	49.604	—
48 CIOD	50.800	47.888	1.355	24.78	56.624	—
PS115, ASTM F679						
18	18.701	17.261	0.671	8.00	21.581	28.49
21	22.047	20.349	0.791	9.50	25.443	—
24	24.803	22.891	0.889	9.60	28.627	—
27	27.953	25.799	1.002	10.10	32.261	—
30 CIOD	32.000	29.070	1.148	16.75	36.348	—
36 CIOD	38.300	35.464	1.373	19.02	45.438	—
42 CIOD	44.500	41.072	1.596	22.43	51.356	—
48 CIOD	50.800	46.886	1.822	24.78	58.628	—

* For data, sizes, or classes not reflected in these charts, please contact JM Eagle™ for assistance.

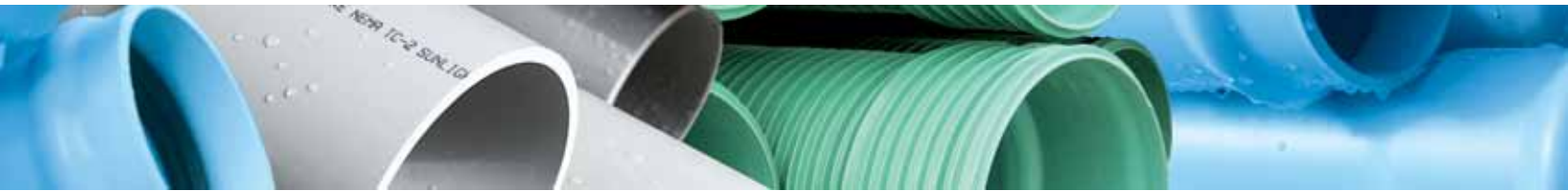

DIMENSIONS AND WEIGHTS

(CONTINUED)

SUBMITTAL AND DATA SHEET

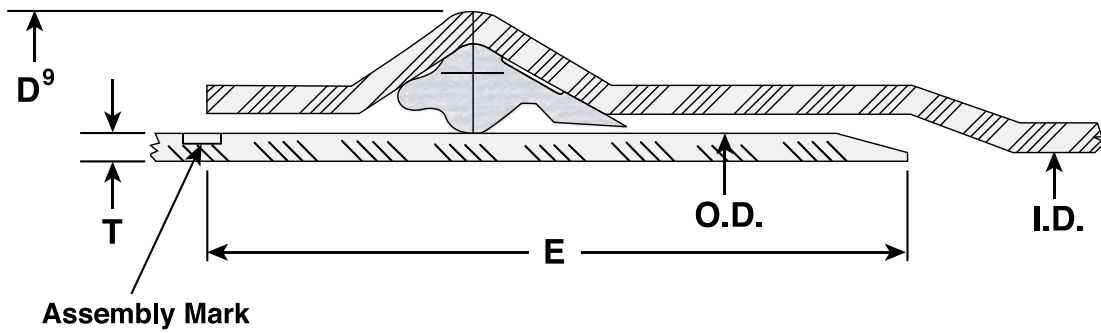

- I.D. : Inside Diameter
- O.D. : Outside Diameter
- T. : Wall Thickness
- D^9 : Bell Outside Diameter
- E: Distance between Assembly Mark to the end of spigot.

04

FLOW/DISCHARGE CHARTS

SIZE (IN)	SLOPE (FT)	VELOCITY (FT/S)	DISCHARGE (FT ³ /s)	RATE (× 1000 GPD)	SIZE (IN)	SLOPE* (FT)	VELOCITY (FT/S)	DISCHARGE (FT ³ /s)	RATE (× 1000 GPD)
4	0.001	0.99	0.08	54.69	12	0.001	2.04	1.53	990.88
	0.002	1.40	0.12	77.35		0.002	2.89	2.17	1,401.32
	0.003	1.71	0.15	94.73		0.003	3.54	2.66	1,716.26
	0.004	1.98	0.17	109.38		0.004	4.08	3.07	1,981.77
	0.005	2.21	0.19	122.29		0.005	4.57	3.43	2,215.68
	0.006	2.42	0.21	133.97		0.006	5.00	3.76	2,427.16
	0.007	2.62	0.22	144.70		0.007	5.40	4.06	2,621.63
	0.008	2.80	0.24	154.69		0.008	5.77	4.34	2,802.64
	0.009	2.97	0.25	164.07		0.009	6.12	4.60	2,972.65
	0.010	3.13	0.27	172.95		0.010	6.46	4.85	3,133.45
6	0.001	1.29	0.24	157.83	15	0.001	2.34	2.63	1,701.09
	0.002	1.82	0.35	223.21		0.002	3.31	3.72	2,405.71
	0.003	2.23	0.42	273.38		0.003	4.05	4.56	2,946.38
	0.004	2.58	0.49	315.67		0.004	4.67	5.26	3,402.19
	0.005	2.88	0.55	352.93		0.005	5.23	5.89	3,803.76
	0.006	3.16	0.60	386.61		0.006	5.72	6.45	4,166.81
	0.007	3.41	0.65	417.59		0.007	6.18	6.96	4,500.67
	0.008	3.65	0.69	446.42		0.008	6.61	7.44	4,811.42
	0.009	3.87	0.73	473.50		0.009	7.01	7.90	5,103.28
	0.010	4.08	0.77	499.11		0.010	7.39	8.32	5,379.33
8	0.001	1.57	0.53	343.77	18	0.001	2.67	4.49	2,903.56
	0.002	2.22	0.75	486.17		0.002	3.78	6.35	4,106.25
	0.003	2.71	0.92	595.43		0.003	4.63	7.78	5,029.11
	0.004	3.13	1.06	687.55		0.004	5.34	8.99	5,807.12
	0.005	3.50	1.19	768.70		0.005	5.97	10.05	6,492.56
	0.006	3.84	1.30	842.07		0.006	6.54	11.00	7,112.24
	0.007	4.15	1.41	909.54		0.007	7.07	11.89	7,682.10
	0.008	4.43	1.50	972.34		0.008	7.56	12.71	8,212.51
	0.009	4.70	1.60	1,031.32		0.009	8.01	13.48	8,710.68
	0.010	4.96	1.68	1,087.11		0.010	8.45	14.21	9,181.86
10	0.001	1.82	0.96	623.30	21	0.001	2.98	6.97	4,503.45
	0.002	2.57	1.36	881.48		0.002	4.22	9.85	6,368.83
	0.003	3.15	1.67	1,079.59		0.003	5.16	12.07	7,800.20
	0.004	3.64	1.93	1,246.60		0.004	5.96	13.94	9,006.89
	0.005	4.07	2.16	1,393.74		0.005	6.67	15.58	10,070.01
	0.006	4.45	2.36	1,526.77		0.006	7.30	17.07	11,031.14
	0.007	4.81	2.55	1,649.10		0.007	7.89	18.44	11,915.00
	0.008	5.14	2.73	1,762.96		0.008	8.43	19.71	12,737.67
	0.009	5.45	2.89	1,869.91		0.009	8.94	20.90	13,510.34
	0.010	5.75	3.05	1,971.05		0.010	9.43	22.03	14,241.14

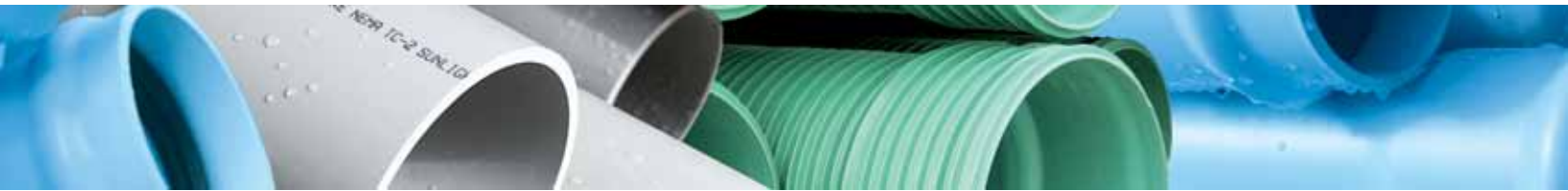

SIZE (IN)	SLOPE (FT)	VELOCITY (FT/S)	DISCHARGE (FT ³ /s)	RATE (× 1000 GPD)	SIZE (IN)	SLOPE* (FT)	VELOCITY (FT/S)	DISCHARGE (FT ³ /s)	RATE (× 1000 GPD)
24	0.001	3.22	9.54	6,165.35	30	0.001	3.78	18.04	11,657.79
	0.002	4.56	13.49	8,719.12		0.002	5.35	25.51	16,486.60
	0.003	5.59	16.52	10,678.70		0.003	6.55	31.24	20,191.88
	0.004	6.45	19.08	12,330.70		0.004	7.56	36.08	23,315.57
	0.005	7.21	21.33	13,786.15		0.005	8.46	40.33	26,067.60
	0.006	7.90	23.37	15,101.97		0.006	9.26	44.18	28,555.63
	0.007	8.53	25.24	16,311.99		0.007	10.00	47.72	30,843.61
	0.008	9.12	26.98	17,438.25		0.008	10.69	51.02	32,973.20
	0.009	9.67	28.62	18,496.05		0.009	11.34	54.11	34,973.36
	0.010	10.20	30.17	19,496.55		0.010	11.96	57.04	36,865.16
27	0.001	3.49	13.12	8,481.06	36	0.001	4.39	32.70	21,136.17
	0.002	4.94	18.56	11,994.03		0.002	6.21	46.25	29,891.05
	0.003	6.05	22.73	14,689.63		0.003	7.60	56.64	36,608.91
	0.004	6.98	26.24	16,962.12		0.004	8.78	65.41	42,272.33
	0.005	7.81	29.34	18,964.23		0.005	9.81	73.13	47,261.91
	0.006	8.55	32.14	20,774.27		0.006	10.75	80.11	51,772.82
	0.007	9.24	34.72	22,438.78		0.007	11.61	86.52	55,921.04
	0.008	9.88	37.12	23,988.07		0.008	12.41	92.50	59,782.11
	0.009	10.48	39.37	25,443.19		0.009	13.16	98.11	63,408.50
	0.010	11.04	41.50	26,819.47		0.010	13.87	103.42	66,838.43

* Based of full flow.

05

EXTERNAL LOADS

BACKGROUND

Loads imposed on buried conduits have, in past practice, been calculated by using the Marston load formula. For trench loads, Marston has a formula for rigid pipe and another formula for flexible pipe. It is important to recognize that under identical conditions of burial, the soil load generated on a flexible conduit is less than the load generated on a rigid conduit. The comparative load on a rigid conduit versus the load on a flexible conduit is expressed as the ratio of trench width to the flexible pipe O.D. By definition, a flexible conduit is one which will deflect before reaching failure.

MARSTON'S FORMULAS FOR SOIL LOADS

$$\text{Rigid Pipe } W = C_d w B_d^2$$
$$\text{Flexible Pipe } W = C_d w B_c B_d$$

Where: **W** = Load on pipe (lb/lin ft)
C_d = Load Coefficient
w = Soil unit weight (lb/ft³)
B_d = Ditch width (ft)
B_c = O.D. of pipe (ft)

PRISM LOAD

Although loads imposed on buried conduits have been calculated by using the Marston load formulas for rigid and flexible pipe, it has been determined that the Marston formula for flexible pipe may not determine the maximum long term load. The "Prism Load" formula is more conservative. "Prism Load" refers to the weight of the column of soil directly above the pipe. When the prism load is used, precautions in keeping the trench narrow are unnecessary for a flexible pipe installation. The important thing is to compact the haunching material from the pipe out to the undisturbed trench walls.

$$\text{PRISM LOAD: } P_v = wH \text{ (lbs/ft}^2\text{)}$$

Where: **P_v** = Pressure at the top of the pipe due to the weight of the soil (lb/ft²)
w = Soil unit weight (lb/ft³)
H = Depth from top of pipe to top of ground (ft)

LIVE LOADS

Live loads imposed on buried conduits from traffic must also be considered in a design and become more important at shallow depths. The soil load and live load must be added to determine the total external load on a buried conduit. This combined load should be used for design. **Figure 1** illustrates the magnitude of soil and live loads separately and also charts the magnitude of the combined or total loads. The curves in **Figure 1** apply only for H20 highway loading and a soil weight of 120 lbs/cu ft.

At shallow depths of cover (less than 3 feet), flexible conduits can deflect and rebound under dynamic loading conditions if the trench width is not sufficiently bridged. Therefore, for shallow installations under flexible road surfaces (between 1 and 3 feet), JM Eagle™ recommends Class I* material be used in the pipe zone and up to the road elevation. This recommendation is not meant to conflict with the design engineer's specifications as his specifications will govern.

* See page 18 for definition of Class I materials.

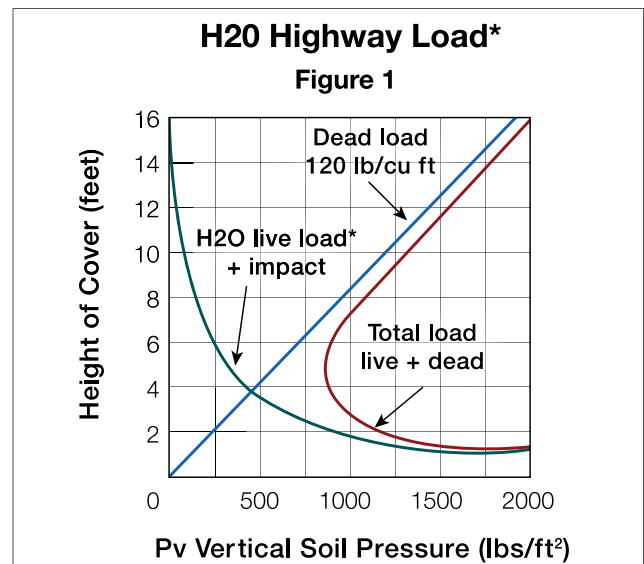

* Live load applied on assumed area of 36" x 40".

Note: To convert vertical soil pressure to load on pipe pounds per linear foot—multiply by O.D. of pipe in ft.

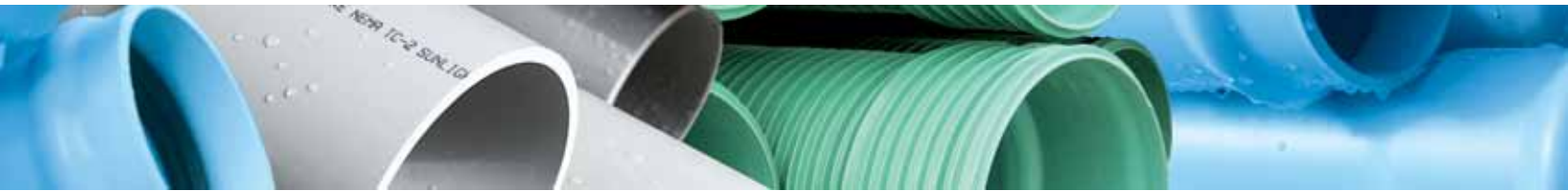

PRISM LOAD ON FLEXIBLE PVC SEWER PIPE (LB/LIN FT)

TABLE 1

HEIGHT OF COVER FEET	SOIL WT. LB/FT ³	PIPE DIAMETER (IN)											
		4	6	8	10	12	15	18	21	24	27	30	36
3	100	105	157	210	263	313	383	468	551	620	699	787	984
	110	116	173	231	289	344	421	514	606	682	769	866	1083
	120	126	188	252	315	375	459	561	661	744	839	945	1181
4	100	141	209	280	350	417	510	623	735	827	932	1050	1312
	110	155	230	308	385	458	561	686	808	909	1025	1155	1444
	120	169	251	336	420	500	612	748	882	992	1118	1260	1575
5	100	176	261	350	438	521	638	779	919	1033	1165	1312	1640
	110	193	288	385	481	573	701	857	1010	1137	1281	1444	1804
	120	211	314	420	525	625	765	935	1102	1240	1398	1575	1969
6	100	228	340	455	569	677	829	1013	1194	1343	1514	1706	2133
	110	246	366	490	613	729	893	1091	1286	1447	1631	1837	2297
	120	274	408	546	683	813	995	1216	1433	1612	1817	2047	2559
7	100	246	366	490	613	729	893	1091	1286	1447	1631	1837	2297
	110	270	403	539	674	802	982	1200	1415	1592	1794	2021	2526
	120	295	439	588	735	875	1071	1309	1543	1736	1957	2205	2756
8	100	320	476	637	796	948	1160	1418	1672	1881	2120	2388	2986
	110	320	476	637	796	948	1160	1418	1672	1881	2120	2388	2986
	120	320	476	637	796	948	1160	1418	1672	1881	2120	2388	2986
9	100	281	418	560	700	833	1020	1247	1470	1654	1864	2100	2625
	110	309	460	616	770	917	1122	1371	1617	1819	2050	2310	2887
	120	337	502	672	840	1000	1224	1496	1764	1984	2236	2520	3150
10	100	365	544	728	910	1083	1326	1621	1911	2150	2423	2730	3412
	110	316	471	630	788	938	1148	1403	1654	1860	2096	2362	2953
	120	348	518	693	866	1031	1262	1543	1819	2046	2306	2598	3248
11	100	379	565	756	945	1125	1377	1683	1984	2232	2516	2835	3543
	110	411	612	819	1024	1219	1492	1823	2150	2418	2725	3071	3839
	120	457	680	910	1138	1354	1658	2026	2388	2687	3028	3412	4265
12	100	386	575	770	963	1146	1403	1714	2021	2274	2562	2887	3609
	110	425	633	847	1059	1260	1543	1886	2223	2501	2819	3176	3970
	120	464	690	924	1155	1375	1683	2057	2425	2728	3075	3465	4331
13	100	502	748	1001	1251	1490	1823	2229	2627	2956	3331	3753	4692
	110	422	628	840	1050	1250	1530	1870	2205	2480	2795	3150	3937
	120	464	690	924	1155	1375	1683	2057	2425	2728	3075	3465	4331
14	100	506	753	1008	1260	1500	1836	2244	2646	2976	3354	3780	4724
	110	548	816	1092	1365	1625	1989	2431	2866	3224	3634	4094	5118
	120	594	884	1183	1479	1760	2155	2634	3105	3493	3937	4436	5545
15	100	492	732	980	1225	1458	1785	2182	2572	2894	3261	3675	4593
	110	541	805	1078	1348	1604	1964	2400	2829	3183	3587	4042	5052
	120	590	879	1176	1470	1750	2142	2618	3087	3472	3913	4409	5512
16	100	639	952	1274	1593	1896	2321	2836	3344	3762	4240	4777	5971
	110	639	952	1274	1593	1896	2321	2836	3344	3762	4240	4777	5971
	120	639	952	1274	1593	1896	2321	2836	3344	3762	4240	4777	5971



EXTERNAL LOADS

(CONTINUED)

PRISM LOAD ON FLEXIBLE PVC SEWER PIPE (LB/LIN FT)

TABLE 1 (CONTINUED)

HEIGHT OF COVER FEET	SOIL WT. LB/FT ³	PIPE DIAMETER (IN)											
		4	6	8	10	12	15	18	21	24	27	30	36
15	100	527	784	1050	1313	1563	1913	2338	2756	3100	3494	3937	4921
	110	580	863	1155	1444	1719	2104	2571	3031	3410	3844	4331	5413
	120	632	941	1260	1575	1875	2295	2805	3307	3720	4193	4724	5906
	130	685	1020	1365	1706	2031	2486	3039	3583	4030	4542	5118	6398
16	100	562	837	1120	1400	1667	2040	2493	2940	3307	3727	4199	5249
	110	618	920	1232	1540	1833	2244	2743	3234	3638	4100	4619	5774
	120	674	1004	1344	1680	2000	2448	2992	3528	3968	4472	5039	6299
	130	731	1088	1456	1820	2167	2652	3242	3821	4299	4845	5459	6824
17	100	597	889	1190	1488	1771	2168	2649	3123	3514	3960	4462	5577
	110	657	978	1309	1636	1948	2384	2914	3436	3865	4356	4908	6135
	120	717	1067	1428	1785	2125	2601	3179	3748	4217	4752	5354	6693
	130	776	1156	1547	1934	2302	2818	3444	4060	4568	5148	5801	7251
18	100	632	941	1260	1575	1875	2295	2805	3307	3720	4193	4724	5906
	110	695	1035	1386	1733	2063	2525	3086	3638	4092	4612	5197	6496
	120	759	1130	1512	1890	2250	2754	3366	3968	4465	5032	5669	7087
	130	822	1224	1638	2048	2438	2984	3647	4299	4837	5451	6142	7677
19	100	667	994	1330	1663	1979	2423	2961	3491	3927	4426	4987	6234
	110	734	1093	1463	1829	2177	2665	3257	3840	4320	4868	5486	6857
	120	801	1192	1596	1995	2375	2907	3553	4189	4713	5311	5984	7480
	130	868	1292	1729	2161	2573	3149	3849	4538	5105	5754	6483	8104
20	100	703	1046	1400	1750	2083	2550	3117	3675	4134	4659	5249	6562
	110	773	1150	1540	1925	2292	2805	3429	4042	4547	5125	5774	7218
	120	843	1255	1680	2100	2500	3060	3740	4409	4961	5591	6299	7874
	130	913	1360	1820	2275	2708	3315	4052	4777	5374	6056	6824	8530
21	100	738	1098	1470	1838	2188	2678	3273	3858	4341	4892	5512	6890
	110	811	1208	1617	2021	2406	2945	3600	4244	4775	5381	6063	7579
	120	885	1318	1764	2205	2625	3213	3927	4630	5209	5870	6614	8268
	130	959	1428	1911	2389	2844	3481	4254	5016	5643	6359	7165	8957
22	100	773	1150	1540	1925	2292	2805	3429	4042	4547	5125	5774	7218
	110	850	1265	1694	2118	2521	3086	3771	4446	5002	5637	6352	7940
	120	927	1381	1848	2310	2750	3366	4114	4850	5457	6150	6929	8661
	130	1005	1496	2002	2503	2979	3647	4457	5255	5911	6662	7507	9383
23	100	808	1203	1610	2013	2396	2933	3584	4226	4754	5358	6037	7546
	110	889	1323	1771	2214	2635	3226	3943	4648	5229	5893	6640	8301
	120	969	1443	1932	2415	2875	3519	4301	5071	5705	6429	7244	9055
	130	1050	1564	2093	2616	3115	3812	4660	5493	6180	6965	7848	9810
24	100	843	1255	1680	2100	2500	3060	3740	4409	4961	5591	6299	7874
	110	927	1381	1848	2310	2750	3366	4114	4850	5457	6150	6929	8661
	120	1012	1506	2016	2520	3000	3672	4488	5291	5953	6709	7559	9449
	130	1096	1632	2184	2730	3250	3978	4862	5732	6449	7268	8189	10236
25	100	878	1307	1750	2188	2604	3188	3896	4593	5167	5824	6562	8202
	110	966	1438	1925	2406	2865	3506	4286	5052	5684	6406	7218	9022
	120	1054	1569	2100	2625	3125	3825	4675	5512	6201	6988	7874	9843
	130	1142	1699	2275	2844	3385	4144	5065	5971	6717	7571	8530	10663

DEFLECTION AND TESTING

Deflection is defined as the change in vertical inside diameter of a flexible conduit when subjected to a vertical load. The amount of deflection that will occur in any flexible conduit is a function of three factors:

1. Pipe Stiffness ($F/\Delta y$)
2. Soil Stiffness
3. Load on the pipe

It is important to recognize that flexible conduits perform differently in the ground than they do under laboratory flat plate loading. The interaction of pipe stiffness and soil stiffness combine to give flexible conduits a high effective strength when buried.

METHODS FOR PREDICTING PIPE DEFLECTION

The most commonly used approach in predicting deflection has been the modified "Iowa Deflection Formula."

Modified Iowa Formula:

$$\Delta y = \frac{DL K W r^3}{EI + .061 E' r^3}$$

Where:

Δy = vertical deflection (inches)

DL = lag factor (1.5 maximum)

K = bedding factor

W = earth load (lb/in)

r = mean radius ($\frac{OD - t}{2}$) (in)

E = PVC modulus of elasticity (lb/in²)

I = moment of inertia $t^3/12$ (in³)

E' = soil modulus (lb/in²)

t = minimum wall thickness

Although considered a conservative approach, considerable variation in predicted deflection will result depending upon the choice of empirical constants E', K and DL.

Empirical methods of predicting deflection have evolved in recent years, which eliminate the guesswork inherent in the

Iowa method. When design is based on actual laboratory tests and previous field measurements, it is unnecessary to know the actual load acting on the pipe or the soil stiffness. Thus an installation can be designed with a known factor of safety provided enough empirical data is available.

To accommodate the problem of having to establish data for the number of trench widths that are found in the field, the prism load was chosen because it represents the maximum loading condition on a flexible pipe. Time lag to account for future settlement of the backfill can be included by choosing long term values of deflection.

JM Eagle™ has developed, through laboratory tests and actual field data, the maximum long term deflection chart, **Figure 2**, shown on page 15. This chart eliminates the guesswork in predicting deflection and gives the design engineer a quick ready reference. This chart is for PVC SDR 35 and SDR 26 Heavy Wall Sewer pipe. The values given for deflection limits are the ultimate long term deflection that will occur in a particular soil class having a given density (compaction) in the haunching area of the pipe zone for various heights of cover (feet).





DEFLECTION AND TESTING

(CONTINUED)

MAXIMUM LONG TERM DEFLECTION

1. Where live loads are not a factor or not involved in the total external load on the pipe, the charts can be used directly to determine the limit of the maximum long-term deflection of the PVC pipe.

Example: If an 8" PVC SDR 35 Sewer Pipe is installed in Class IV material, having 85% compaction in the pipe zone and with 12 feet of cover, what will be the maximum long term deflection limit?

Answer: Pipe will never deflect more than 5% (color code—dark blue)

2. Where live loads must be considered, first, determine the combined total external load on the pipe. Next, determine the equivalent prism load (without live load) for the particular pipe size involved using the table of prism loads, **Table 1**. Read across to the left for the height of cover (ft) for the equivalent prism load. Using this height of cover with the bedding class and proctor density, enter the maximum long term deflection chart, **Figure 2**, to determine the maximum long term deflection limit.

Example: If a 12" PVC SDR 35 Sewer Pipe is installed in Class III material, having 65% compaction in the pipe zone, with 3 feet of cover, and 120 lbs/ft³ soil, and H-20 (highway load) live load are imposed on the buried pipe, what will be the maximum long term deflection limit?

Answer: **1.** The combined (dead and live) load on the pipe will be approximately 1000 lbs/ft² or 1000 x 1 ft (pipe diameter in feet) = 1000 lbs/lin ft (per **Figure 1**). **2.** Enter table of prism loads (**Table 1**) under column 12—Pipe Diameter (inches)—and read down until nearest figure to 1000 is reached, across from soil wt. of 120 lbs/ft³. In this case, 1000 appears opposite 120 lbs/ft³ and 8 ft—height of cover. This represents the equivalent prism load for the combined (dead and live) load given above. **3.** Now enter maximum long term deflection chart and read the maximum long term deflection color code for Class III bedding classification, 65% density, and 8 ft of cover. Dark blue—maximum long term deflection will not exceed 5%.

In working with these charts, it becomes apparent that:

1. Soil density in the pipe zone plays a greater role than soil type in the control of deflection in buried flexible conduits.
2. The amount of deflection is independent of pipe size, providing all pipe sizes are of the same pipe stiffness. Pipe size does not appear in the chart for maximum long term deflections.

Note:

Deflection values shown do not include effect of live load or longitudinal bending.

1. No length of pipe installed under conditions specified will deflect more than is indicated; the pipe will deflect less than the amount indicated if specified density is obtained.
2. External loading based upon soil weight of 120 lbs per cubic foot.
3. Deflections predicted are based upon pipe which was initially circular prior to installation.
Actual deflections may differ because of initial out of roundness caused by storage and/or handling. These variations should be taken into account when measured deflections are compared with those in the table.
4. Bedding classifications are as indicated on page 14 and correspond to ASTM D2321.
5. Deflections listed in **Figure 2** are maximum long term values. The suggested maximum long term value is 7.5 percent which is approximately equal to a 5 percent initial deflection.
6. Initial deflection is deflection taken within the first 24 hours after trench is backfilled.

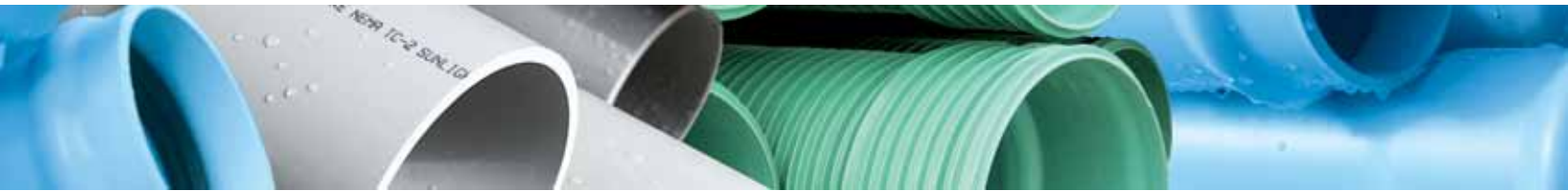

MAXIMUM LONG-TERM % DEFLECTION OF PVC PIPE

FIGURE 1 PIPE STIFFNESS 115 psi

ASTM BEDDING CLASSIFICATION		DENSITY (PROCTOR) AASHTO T-99	HEIGHT OF COVER (FEET)														
			3	5	8	10	12	14	16	18	20	22	24	26	28	30	
GRAVEL	CLASS I*		█	█	█	█	█	█	█	█	█	█	█	█	█	█	
	CLASS II	90 %	█	█	█	█	█	█	█	█	█	█	█	█	█	█	
		80 %	█	█	█	█	█	█	█	█	█	█	█	█	█	█	
SAND	CLASS III	90 %	█	█	█	█	█	█	█	█	█	█	█	█	█	█	
		85 %	█	█	█	█	█	█	█	█	█	█	█	█	█	█	
		75 %	█	█	█	█	█	█	█	█	█	█	█	█	█	█	█
		65 %	█	█	█	█	█	█	█	█	█	█	█	█	█	█	
CLAY	CLASS IV	85 %	█	█	█	█	█	█	█	█	█	█	█	█	█	█	
		75 %	█	█	█	█	█	█	█	█	█	█	█	█	█	█	█
		65 %	█	█	█	█	█	█	█	█	█	█	█	█	█	█	█
PEAT	CLASS V		This soil class not recommended														

- Maximum 7.5% deflection
- Maximum deflection will not exceed 5%
- This zone is not recommended

FIGURE 2 PIPE STIFFNESS 46 psi

ASTM BEDDING CLASSIFICATION		DENSITY (PROCTOR) AASHTO T-99	HEIGHT OF COVER (FEET)														
			3	5	8	10	12	14	16	18	20	22	24	26	28	30	
GRAVEL	CLASS I*		█	█	█	█	█	█	█	█	█	█	█	█	█	█	
	CLASS II	90 %	█	█	█	█	█	█	█	█	█	█	█	█	█	█	
		80 %	█	█	█	█	█	█	█	█	█	█	█	█	█	█	
SAND	CLASS III	90 %	█	█	█	█	█	█	█	█	█	█	█	█	█	█	
		85 %	█	█	█	█	█	█	█	█	█	█	█	█	█	█	
		75 %	█	█	█	█	█	█	█	█	█	█	█	█	█	█	█
		65 %	█	█	█	█	█	█	█	█	█	█	█	█	█	█	
CLAY	CLASS IV	85 %	█	█	█	█	█	█	█	█	█	█	█	█	█	█	
		75 %	█	█	█	█	█	█	█	█	█	█	█	█	█	█	█
		65 %	█	█	█	█	█	█	█	█	█	█	█	█	█	█	█
PEAT	CLASS V		This soil class not recommended														

* See **Figure 3** for detailed plot of this soil class.

- Maximum 7.5% deflection
- Maximum deflection will not exceed 5%
- This zone is not recommended



DEFLECTION AND TESTING

(CONTINUED)

FIGURE 3

GRAVITY SEWER DEFLECTION BY DEPTH OF BURIAL : : †

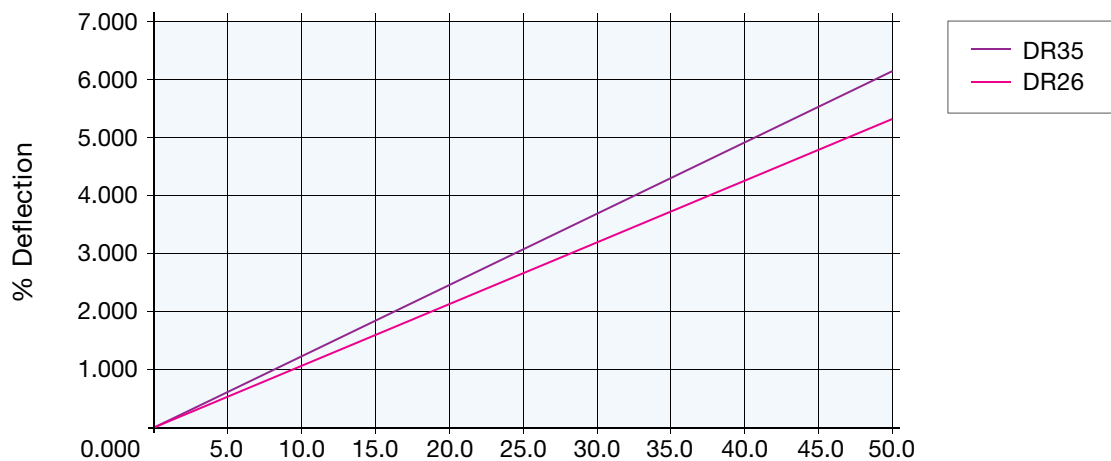

: : Deflections computed using a unit weight of backfill at 120 lbs/cft and assume no internal pressure or live load.

: : Pipe embedment used in calculations is Class 1, 2, 3, or 4, as defined in ASTM D2321 with appropriate compaction to achieve an $E' = 1000$ psi. (see page 18-19)

† Based on calculation methods and design tables set forth by the Uni-Bell® PVC Pipe Association, “Handbook of PVC Pipe Design and Construction.”

DEFLECTION TESTING—WHEN IS IT NEEDED?

JM Eagle’s position on deflection testing is that routine measurement of deflection of installed PVC sewer pipe (SDR 35/26), is totally unnecessary and uneconomical—a superfluous added construction cost for PVC sewer pipe installations. This position applies to all routine deflection testing whether performed by the “Go-No Go Gauge” method for compliance to maximum

TABLE 2

(SDR 35/26)		EQUIV. LINEAR OFFSET (INCHES)	
NOMINAL SIZE (IN)	MIN. RADIUS (FT)	20' LENGTH	14' LENGTH
4	100	24.0	11.7
6	150	16.0	7.8
8	200	12.0	5.9
10	250	9.6	4.7
12	300	8.0	3.9

deflection limits or by instruments which measure and record actual pipe deflections. When recommended installation practices are followed, including required compaction in the haunching area, pipe deflection will not exceed our recommended long term deflection limit of 7.5%. At this deflection limit, the PVC SDR 35 sewer pipe will have a minimum factor of safety of 4" deflection failure.

Proof of this position is that more than 500 million feet of PVC sewer pipe are performing satisfactorily in the field today. On the other hand, where improper installation practices are known or suspected, questionable bedding materials are employed and/or installation conditions are severe, deflection testing of these sections of the sewer pipe installation should be considered advisable by the engineer.

INSTALLATION

PIPE ZONE TERMINOLOGY

FIGURE 4

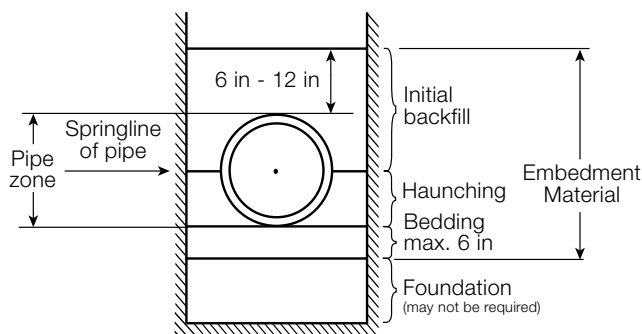

PREPARATION OF THE TRENCH BOTTOM

The trench floor should be constructed to provide a firm, stable, and uniform support for the full length of the pipe. This can be accomplished by bringing the entire trench floor to a level grade and then creating bell holes at each joint to permit proper joint assembly, alignment, and support. Portions of the trench that are excavated below grade should be returned to grade and compacted as required to provide proper support. If the native trench soil is not suitable for the pipe bedding, the trench should be over excavated and refilled with suitable foundation material as specified by the engineer. A cushion of acceptable bedding material should always be provided between any hard foundation and the pipe. Large rocks, boulders, and stones should be removed to allow a minimum of 4 inches of soil cushion on all sides of the pipe and accessories.

PIPE LAYING

Proper implements, tools, and equipment should be used for placement of the pipe in the trench to prevent damage. Avoid dropping pipe and accessories into the trench, as this may cause damage that is not easily detected. Additional handling instructions may be sought from our product installation guides or by contacting JM Eagle™.

In general, pipe laying should begin at the lowest point and work toward manholes, service branches, or clean-outs. Pipe bells can be laid in either direction, upstream or downstream without any significant hydraulic loss. However, common practice is to lay the bells in the direction of work progress to ease installation. Additionally, by inserting the spigot into the bell rather than pushing the bell over the spigot, the risk of soil or rubble being scooped under the gasket is reduced. If pipe laying is interrupted or halted, the exposed ends of the pipe line should be closed to prevent the entrance of trench water, mud, and foreign matter.

BEDDING

Bedding is required primarily to bring the trench bottom up to grade. Bedding materials should be placed to provide uniform longitudinal support under the pipe to prevent low spots. Blocking should not be used to bring the pipe to grade. Bell holes at every joint will allow for the joint to be assembled properly and maintain adequate support. Under normal circumstances a bedding of 4 to 6 inches is sufficient.

HAUNCHING

The most important factor in assuring proper pipe-soil interaction is the haunching material and its density. This material provides the majority of the support that the pipe requires to function properly in regards to performance and deflection. This material should be placed and consolidated under the pipe haunches, the area of the pipe between the springline and the bottom of the pipe, to provide adequate side support to the pipe. In doing so, proper control should be exercised to avoid vertical and horizontal displacement of the pipe from proper alignment. If the bedding material is coarse and contains voids, the same coarse material should also be used for the haunching. In order for the haunching to provide adequate support, it must be consolidated at regular intervals to the springline of the pipe.



INSTALLATION

(CONTINUED)

INITIAL BACKFILL

This portion of the pipe embedment begins at the spring-line of the pipe and extends to some predetermined distance above the top of the pipe. Since little to no side support is derived from the soils placed in this area, native soils may be used without any special compaction efforts. However, if other structures are present such as, roadways or buildings, their foundation requirements may require that this soil be consolidated. The main purpose of the placement of this native material is to protect the pipe from contact with falling rocks or other impact loads that may occur when the final backfill is applied.

At shallow depths of cover (less than three feet), flexible conduits may deflect and rebound under dynamic loading conditions if the trench width is not highly compacted. If this high degree of compaction is not met, road surfaces may be damaged. For pipe buried under flexible road surfaces at depths less than three feet, it is recommended that a minimum of 95% Proctor density be achieved from the bottom of the trench up to the road surface using Class I or Class II materials as described in the following tables. Minimum cover is recommended to be one foot from the top of rigid road surfaces or the bottom of flexible road surfaces.

FINAL BACKFILL

The material used in the final backfilling of the trench need not be as carefully selected as the bedding, haunching, and initial backfill, with the exception of where this material is going to be in the zone of influence of the foundation for some present or future structure. In the final backfill material the following items should be avoided: boulders, frozen clumps of dirt, and rubble that could cause damage to the pipe. Unless otherwise specified, the final backfill material should be placed using special compaction under improved surfaces and shoulders of streets, roads, aprons, curbs, and walks. Under open fields, lawns, and wide shoulders, unimproved right-of-way, or neutral grounds free of traffic, final backfill should be placed using natural compaction. Special compaction requirements should be defined by the design engineer. Natural compaction is attained by the loose placing of

material into the trench, rolling the surface layer with the placement equipment, molding the surface, and filling and maintaining all sunken trenches until final acceptance of the work. In natural compaction, the main consolidation results from rainfall and groundwater fluctuations.

EMBEDMENT MATERIALS

Materials suitable for foundation and embedment are classified in the following **Table 1.1**. They include a number of processed materials plus soil types defined according to the Unified Soil Classification System (USCS) in ASTM D2487, "Standard Method for Classification of Soils for Engineering Purposes." **Table 1.2** provides recommendations on the installation and use based on class of soil or aggregates and location within the trench. It is important to engineer all materials used in the pipe trench to work together and with the native material surrounding the trench.

CLASS IA MATERIALS

Class IA materials provide the maximum stability and pipe support for a given density because of the angular interlocking of the material particles. With minimum efforts, these materials can be installed at relatively high densities over a wide range of moisture contents. These materials also have excellent drainage characteristics that may aid in the control of water. These soils are often desirable as embedment in rock cuts where water is frequently encountered. On the other hand, when ground water flow is anticipated, consideration should be given to potential migration of fines from adjacent materials into the open graded Class IA materials.

CLASS IB MATERIALS

These materials are produced by mixing Class IA and natural or processed sands to produce a particle-size distribution that minimizes migration from surrounding soils that may contain fines. They are more widely graded than Class IA and thus require more compaction effort to achieve the minimum density specified. When these materials are properly compacted, these soils exhibit high stiffness and strength, and depending on the amount of fines, may be relatively free draining.

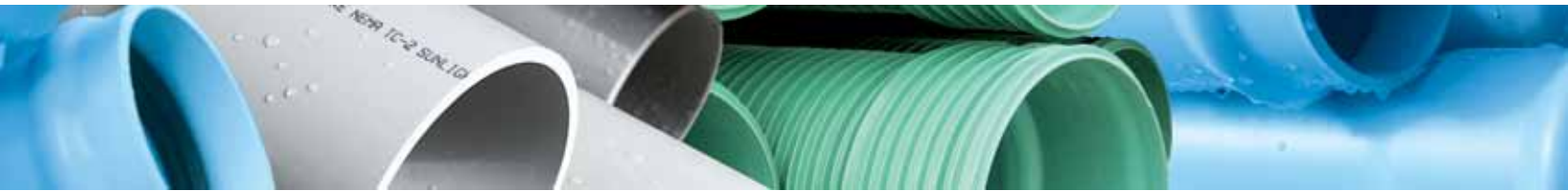

CLASS II MATERIALS

When Class II materials are compacted they provide a relatively high level of pipe support. In most respects, they all have the desirable characteristics of Class IB materials when widely graded. However, open-graded groups may allow for migration and the sizes should be checked for compatibility with the native trench materials. Typically, Class II materials consist of rounded particles and are less stable than the angular materials of Class IA and IB, unless they are confined and compacted.

CLASS III MATERIALS

These materials provide less support for a given density than Class I or Class II materials. High levels of compactive effort are required if moisture content is not controlled. These materials will provide reasonable support once proper compaction is achieved.

CLASS IV-A MATERIALS

Class IV-A materials must be carefully evaluated before use. The moisture content of the materials must be near optimum to minimize compactive effort and achieve the required density. Properly placed and compacted, these soils can provide reasonable levels of pipe support. However, these materials may not be suitable under high fills, surface applied dynamic loads, or under heavy vibratory compactors and tampers. These materials should be avoided if water conditions in the trench may cause instability and result in uncontrolled water content.

MIGRATION

In soils where ground water fluctuations occur, coarse or open-graded material placed adjacent to a finer material may be infiltrated by those fines. Such hydraulic gradients may arise during trench construction when water levels are being controlled by various pumping or well-pointing methods, or after construction when permeable under drain or embedment materials act as a “French” drain under high ground water levels. Downward percolation of

surface water may carry fine materials down into more coarse, open-graded bedding materials if the trench is not properly designed and constructed. The gradation and relative particle size of the embedment and adjacent materials must be compatible in order to minimize migration. As a general precaution, it is recommended that if significant groundwater flow is anticipated, avoid placing coarse, open-graded materials adjacent to finer materials, unless methods are employed to impede migration, such as the use of an appropriate stone filter or fabric along the boundary of incompatible materials.

EMBEDMENT COMPACTION

The moisture content of embedment materials must be maintained within suitable limits to permit placement and compaction to required levels without exhaustive efforts. For non-free draining soils, such as Class III and IV-A, moisture content should be held close to optimum. If water exists in the trench, free-draining embedment materials are generally more suitable because they are more readily densified when saturated. Maximum particle size for embedment material is limited to only those materials passing a 1.5 inch (38 mm) sieve.

When using mechanical compactors, avoid contact with the pipe. When compacting over the pipe crown, a minimum of 6 inches of cover should be maintained when using small compactors. If larger compactors are used, the engineer should be consulted to specify the minimum distance from the pipe crown. This decision will be based on the depth of influence of the specific compaction equipment being used. For compaction with heavy wheel loading or hydro hammer methods, a minimum of 30 inches over the pipe crown is required. Heavy wheel loading or hydro hammer methods should not be used in shallow applications where total cover is less than the influence zone of the compaction device. In shallow cover applications, materials requiring little or no mechanical compaction should be used for embedment of the pipe.



INSTALLATION

(CONTINUED)

The effectiveness of the compaction equipment necessary to achieve desired densities for specific types of materials depends on the chosen methods ability to deliver compactive energy. Coarse-grained, clean materials are free flowing and may not require mechanical compaction in some installations. These materials are more readily compacted using vibratory equipment. Fine materials with high plasticity may require kneading and impact force along with controlled water content to reach acceptable densities. In pipe trenches, small hand-held, or walk behind compactors, work well, not only to prevent pipe damage, but to insure thorough compaction in the confined spaces around the pipe and along the trench wall.

PERMISSABLE HORIZONTAL CURVATURE

Curved sewers, 4" through 12" in diameter, should be accomplished by bending the pipe rather than deflecting the joint, per Table 2. Curves for pipe 15" and larger should be made by an allowable 1.5 degrees deflection at the joint.



SHEETING

If soil conditions or regulations require the use of sheeting or boxes, they should be used in a manner so as not to disturb the haunching material within one pipe diameter on each side of pipe.



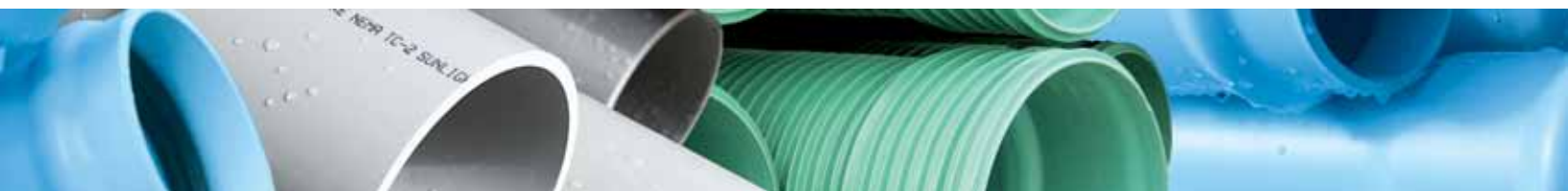

TABLE 1.1

Description of Material Classification as Defined in ASTM D2321

CLASS	TYPE	SOIL SYMBOL GROUP	DESCRIPTION ASTM D2487	PERCENTAGE PASSING SIEVE SIZES .075MM			ATTERBERG LIMITS		COEFFICIENTS	
				1.5 IN (40 MM)	NO. 4 (4.75 MM)	NO. 200 (0.75 MM)	LL	PL	UNIFORMITY CU	CURVATURE Cc
IA	Manufactured Aggregates: open graded clean	none	Angular, crushed stone or rock, crushed slag, cinders or shell large void content, contain little or no fines	100%	< or = 10%	< 5%	Non Plastic	—	—	—
IB	Manufactured, Processed Aggregates: dense graded, clean	none	Angular, crushed stone (or other Class IA materials) and stone/sand mixtures with gradations selected to minimize migration of adjacent soils; contain little to no fines	100%	< or = 50%	< 5%	Non Plastic	—	—	—
II	Coarse-Grained Soils, clean	GW	Well-graded gravels and gravel-sand mixtures; little to no fines	100%	< 50% of coarse fraction	< 5%	Non Plastic	—	> 4	1 to 3
		GP	Poorly-graded gravels and gravel-sand mixtures; little to no fines	—	—	—	—	—	< 4	< 1 or > 3
		SW	Well-graded sands and gravelly sands; little to no fines	—	> 50% of coarse fraction	—	—	—	> 6	1 or 3
		SP	Poorly-graded sands and gravelly sands; little to no fines	—	—	—	—	—	< 6	< 1 or > 3
	Coarse-Grained Soils: borderline clean to with fines		Sands and gravels which are borderline between clean and with fines	100%	varies	5% to 12%	Non Plastic	—	—	Same as for GW, GP, SW, and SP
III	Coarse-Grained Soils with fines	GM	Silty gravels, gravel-sand-silt mixtures	100%	> 50% of coarse fraction	> 12% to < 50%	—	< 4 or <"A" Line	—	—
		GC	Clayey gravels, gravel-sand-clay mixtures	—	—	—	—	< 7 and >"A" Line	—	—
		SM	Silty sands, sand-silt mixtures	—	> 50% of coarse fraction	—	—	> 4 or <"A" Line	—	—
		SC	Clayey sands, sand-silt mixtures	—	—	—	—	> 7 and >"A" Line	—	—
IVA	Fine-Grained Soils: Inorganic	ML	Inorganic silts and very fine sands, rock flour, silty or clayey fine sands, silts with slight plasticity	100%	100%	> 50%	< 50	< 4 or <"A" Line	—	—
		CL	Inorganic clays of low to medium plasticity, gravelly clays, sandy clays, silty clays, lean clays	—	—	—	—	> 7 and >"A" Line	—	—
IVB	Fine-Grained Soils: Inorganic	MH	Inorganic silts, micaceous or diatomaceous fine sandy or silty soils, elastic silts	100%	100%	> 50%	> 50	< "A" Line	—	—
		CH	Inorganic clays of high plasticity, fat clays	—	—	—	—	> "A" Line	—	—
V	Organic Soils	OL	Organic silts and organic silty clays of low plasticity	100%	100%	> 50%	< 50	< 4 or <"A" Line	—	—
		OH	Organic clays of medium to high plasticity organic silts	—	—	—	> 50	<"A" Line	—	—
	Highly Organic	PT	Peat and other high organic soils	—	—	—	—	—	—	—



INSTALLATION

(CONTINUED)

TABLE 1.2

Recommendations for Installation and Use of Soils and Aggregates for Foundation, Embedment and Backfill.

	SOIL CLASS AS DEFINED IN TABLE 1.1				
	CLASS IA	CLASS IB	CLASS II	CLASS III	CLASS IV-A
General Recommendations and Restrictions	Do not use where conditions may cause migration of fines from adjacent soil and loss of pipe support. Suitable for use as a drainage blanket and underdrain in rock cuts where adjacent material is suitably graded.	Process materials as required to obtain gradation which will minimize migration of adjacent materials. Suitable for use as drainage blanket and underdrain.	Where hydraulic gradient exist check gradation to minimize migration. “Clean” groups suitable for use as drainage blanket and underdrain.	Do not use where water conditions in trench may cause instability.	Obtain geotechnical evaluation of processed material. May not be suitable under high earth fills, surface applied loads and under heavy vibratory compactors and tampers. Do not use where water conditions in trench may cause instability.
Foundation	Suitable as foundation and for replacing over-excavated and unstable trench bottom as restricted above. Install and compact in 6 inch maximum layers.	Suitable as foundation and for replacing over-excavated and unstable trench bottom. Install and compact in 6 inch maximum layers.	Suitable as foundation and for replacing over-excavated and unstable trench bottom as restricted above. Install and compact in 6 inch maximum layers.	—	Suitable only in undisturbed conditions and where trench is dry. Remove all loose material and provide firm, uniform trench bottom before bedding is placed.
Bedding	Suitable as restricted above. Install in 6 inch maximum layers. Level final grade by hand. Minimum depth 4 inches (6 inches in rock cuts).	Install and compact in 6 inch maximum layers. Level final grade by hand. Minimum depth 4 inches (6 inches in rock cuts).	Suitable as restricted above. Install and compact in 6 inch maximum layers. Level final grade by hand. Minimum depth 4 inches (6 inches in rock cuts).	Suitable only in dry trench conditions. Install and compact in 6 inch maximum layers. Level final grade by hand. Minimum depth 4 inches (6 inches of rock cuts).	Suitable only in dry trench conditions and when optimum placement and compaction control is maintained. Install and compact in 6 inch maximum layers. Level final grade by hand. Minimum depth 4 inches (6 inches in rock cuts).
Haunching	Suitable as restricted above. Install in 6 inch maximum layers. Work in around pipe by hand to provide uniform support.	Install and compact in 6 inch maximum layers. Work in around pipe by hand to provide uniform support.	Suitable as restricted above. Install and compact in 6 inch maximum layers. Work in around pipe by hand to provide uniform support.	Suitable as restricted above. Install and compact in 6 inch maximum layers. Work in around pipe by hand to provide uniform support.	Suitable only in dry trench conditions and when optimum placement and compaction control is maintained. Install and compact in 6 inch maximum layers. Work in around pipe by hand to provide uniform support.
Initial Backfill	Suitable as restricted above. Install to a minimum of 6 inches above pipe crown.	Install and compact to a minimum of 6 inches above pipe crown.	Suitable as restricted above. Install and compact to a minimum of 6 inches above pipe crown.	Suitable as restricted above. Install and compact to a minimum of 6 inches above pipe crown.	Suitable as restricted above. Install and compact to a minimum of 6 inches above pipe crown.
Final Backfill	Compact as required by the engineer.	Compact as required by the engineer.	Compact as required by the engineer.	Compact as required by the engineer.	Suitable as restricted above. Compact as required by the engineer.

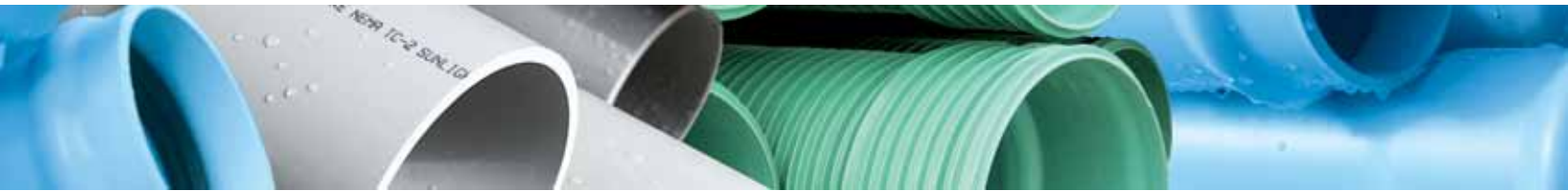

TABLE 1.3

Provides an approximate guide to obtainable densities of various soils by several compaction methods. Minimum densities required will depend on the depth of cover, pipe stiffness, and type of soil used. In most situations, the project engineer will determine the appropriate values during the design.

ESTIMATED RANGE OF COMPACTION BY EMBEDMENT CLASS AND METHOD				
Class of Embedment	I	II	III	IV
Material Description	Manufactured Granular Materials	Sand and Gravel, clean	Mixed-Grain	Fine-Grain
Optimum Moisture Content Range % of dry weight	—	9 to 12	9 to 18	6 to 30
Soil Consolidation Method	% OF PROCTOR (OR RELATIVE) DENSITY RANGE			
Power Tamper or Rammer	95 - 100 (75 - 100)	95 - 100 (80 - 100)	95 - 100	90 - 100
Portable Vibrator	80 - 95 (60 - 75)	80 - 95 (60 - 80)	80 - 95	75 - 90
Consolidation by Saturation	80 - 95 (60 - 75)	80 - 95 (60 - 80)	—	—
Hand Place	60 - 80 (40 - 60)	—	—	—
Hand Tamp	—	60 - 80 (50 - 60)	60 - 80	60 - 75
Dump	60 - 80 (40 - 60)	60 - 80 (50 - 60)	60 - 80	60 - 75

08

FITTINGS AND ADAPTORS

JM Eagle™ offers a complete line of PVC SDR 35 sewer fittings to be used with PVC Ring-Tite™ SDR 35 sewer pipe.

Gasketed tee and wye saddles are available for field service line taps into previously installed PVC sewer lines, which eliminate the need for field solvent welding. Through the large network of JM Eagle™ distributors, adaptors are available to connect JM Eagle™ Ring-Tite™ PVC sewer pipe to other pipe materials.

The fitting illustrations below are representative of the types of fittings and adaptors available. Actual configurations or design of fittings may vary with size or manufacturing origin of the fitting. Ask your JM Eagle™ Sales Representative for more detailed information.

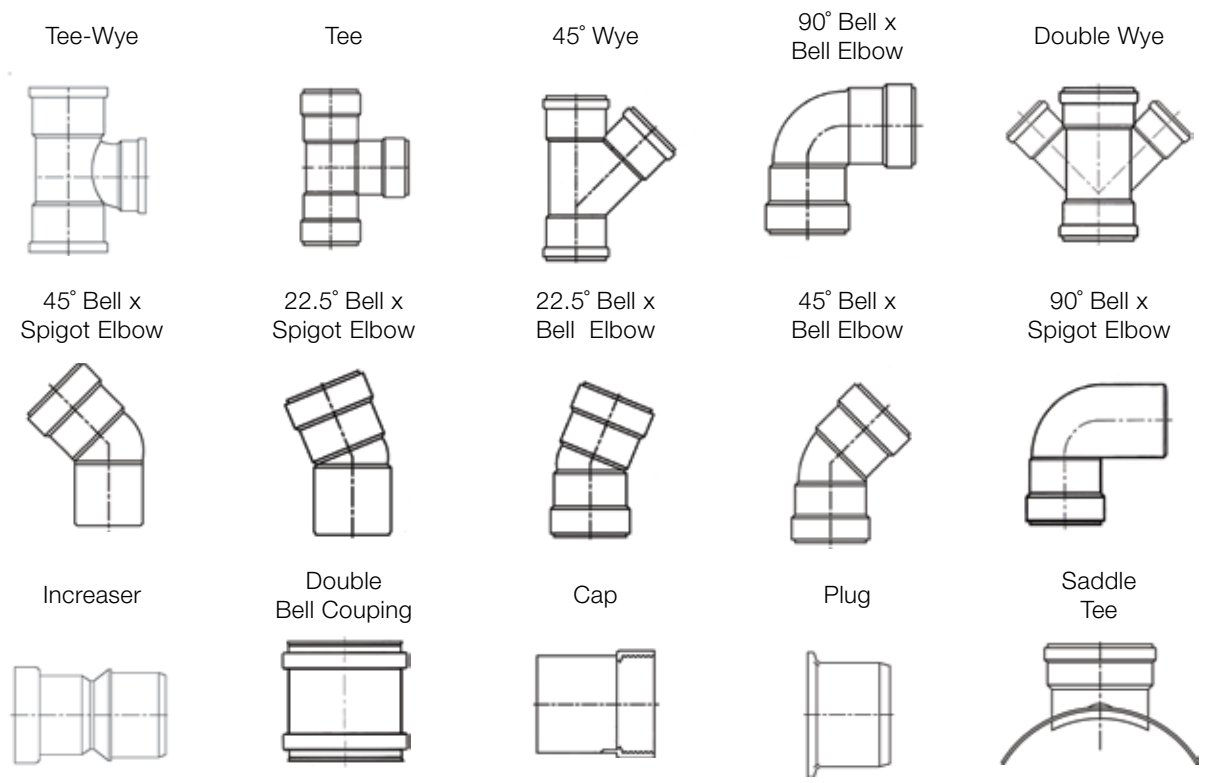

SHORT FORM INSTALLATION GUIDE

This information is furnished in order to provide a brief review of the installation requirements for JM Eagle™ Ring-Tite™ PVC Sewer pipe. It is not intended to serve as or replace the FULL VERSION of the complete product installation guide available upon request.

1. Check to see that the gasket is properly seated in the bell groove, and that the bell and spigot are clean before assembly.
2. Apply the approved lubricant supplied with the pipe to the spigot end of the pipe, paying particular attention to the bevel. The coating should be equivalent to a brush coat of enamel paint.
3. Assemble the joint only to and not over the assembly mark provided on the spigot end.
4. If undue resistance to insertion of the spigot is encountered, or the assembly mark does not reach the flush position, disassemble the joint and check the position of the rubber gasket, and remove any debris.

PIPE SIZE (IN)	RADIUS (FT)
4	100
6	150
8	200
10	250
12	300

5. Curvature of the pipe shall be accomplished through longitudinal bending of the pipe barrel in accordance with the following table. Deflection of the joint is not allowed and may cause leaks. For bending of pipe larger than 12", 1.5 degrees of joint deflection is allowed. This will result in an offset of 6¼" per 20' length.
6. Prior to backfilling, check to see that the reference mark is flush with the end of the bell.



WARRANTY

JM EAGLE™ PRODUCTS LIMITED WARRANTY

J-M Manufacturing Co., Inc. (JM Eagle™) warrants that its standard polyvinyl chloride (PVC), polyethylene (PE), conduit/plumbing/solvent weld and Acrylonitrile-Butadiene-Styrene (ABS) pipe Products (“Products”) are manufactured in accordance with applicable industry specifications referenced on the Product and are free from defects in workmanship and materials. Every claim under this warranty shall be void unless in writing and received by JM Eagle™ within thirty (30) days of the date the defect was discovered, and within one (1) year of the date of shipment from the JM Eagle™ plant. Claims for Product appearance defects, such as sun-bleached pipe etc., however, must be made within thirty (30) days of the date of the shipment from the JM Eagle™ plant. This warranty specifically excludes any Products allowed to become sun-bleached after shipment from the JM Eagle™ plant. Proof of purchase with the date thereof must be presented to the satisfaction of JM Eagle™, with any claim made pursuant to this warranty. JM Eagle™ must first be given an opportunity to inspect the alleged defective Products in order to determine if it meets applicable industry standards, if the handling and installation have been satisfactorily performed in accordance with JM Eagle™ recommended practices and if operating conditions are within standards. Written permission and/or a Return Goods Authorization (RGA) must be obtained along with instructions for return shipment to JM Eagle™ of any Products claimed to be defective.

The limited and exclusive remedy for breach of this Limited Warranty shall be, at JM Eagle’s sole discretion, the replacement of the same type, size and like quantity of non-defective Product, or credits, offsets, or combination of thereof, for the wholesale purchase price of the defective unit.

This Limited Warranty does not apply for any Product failures caused by user’s flawed designs or specifications, unsatisfactory applications, improper installations, use in conjunction with incompatible materials, contact with aggressive chemical agents, freezing or overheating of liquids in the product and any other misuse causes not listed here. This Limited Warranty also excludes failure or damage caused by fire stopping materials, thread sealants, plasticized vinyl Products or damage caused by the fault or negligence of anyone other than JM Eagle™, or any other act or event beyond the control of JM Eagle™.

JM Eagle’s liability shall not, at any time, exceed the actual wholesale purchase price of the Product. The warranties in this document are the only warranties applicable to the Product and there are no other warranties, expressed or implied. This Limited Warranty specifically excludes any liability for general damages, consequential or incidental damages, including without limitation, costs incurred from removal, reinstallation, or other expenses resulting from any defect. **IMPLIED WARRANTIES OF MERCHANTABILITY OR FITNESS FOR A PARTICULAR PURPOSE ARE SPECIFICALLY DISCLAIMED AND JM EAGLE™ SHALL NOT BE LIABLE IN THIS RESPECT NOTWITHSTANDING JM EAGLE’S ACTUAL KNOWLEDGE THE PRODUCT’S INTENDED USE.**

JM Eagle’s Products should be used in accordance with standards set forth by local plumbing and building laws, codes, or regulations and the applicable standards. Failure to adhere to these standards shall void this Limited Warranty. Products sold by JM Eagle™ that are manufactured by others are warranted only to the extent and limits of the warranty of the manufacturer. No statement, conduct or description by JM Eagle™ or its representative, in addition to or beyond this Limited Warranty, shall constitute a warranty. This Limited Warranty may only be modified in writing signed by an officer of JM Eagle™.

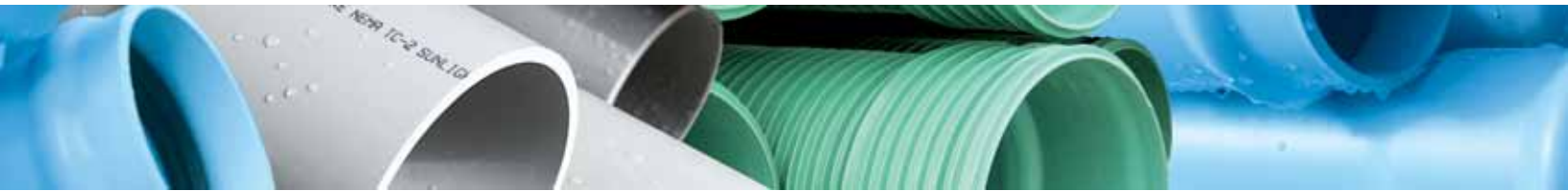

PLANT LOCATIONS

ADEL

2101 J-M Drive
Adel, Georgia 31620

BATCHELOR

2894 Marion Monk Road
Batchelor, Louisiana 70715

BUCKHANNON

Old Drop 33, Mudlick Road
Buckhannon, West Virginia 26201

BUTNER

2602 West Lyon Station Road
Creedmoor, North Carolina 27522

CAMERON PARK

3500 Robin Lane
Cameron Park, California 95682

COLUMBIA

6500 North Brown Station Road
Columbia, Missouri 65202

CONROE

101 East Avenue M
Conroe, Texas 77301

FONTANA

10990 Hemlock Avenue
Fontana, California 92337

HASTINGS

146 North Maple Avenue
Hastings, Nebraska 68901

KINGMAN

4620 Olympic Way
Kingman, Arizona 86401

MAGNOLIA

2220 Duracrete Drive
Magnolia, Arkansas 71753

MCNARY

31240 Roxbury Road
Umatilla, Oregon 97882

MEADVILLE

15661 Delano Road
Cochrannton, Pennsylvania 16314

PERRIS

23711 Rider Street
Perris, California 92570

PUEBLO

1742 E. Platteville Boulevard
Pueblo West, Colorado 81007

STOCKTON

1051 Sperry Road
Stockton, California 95206

SUNNYSIDE

1820 South First Street
Sunnyside, Washington 98944

TACOMA

2330 Port of Tacoma Road
Tacoma, Washington 98421

TULSA

4501 West 49th Street
Tulsa, Oklahoma 74107

VISALIA

8875 Avenue 304
Visalia, California 93291

WHARTON

10807 US 59 RD
Wharton, Texas 77488

WILTON

1314 W. Third Street
Wilton, Iowa 52778

MEXICO

PLASTICS TECHNOLOGY
DE MÉXICO S DE R.L. DE S.A.
Av. Montes Urales No. 8 y 10
Parque Industrial Opción, Carretera
57 Qro. -S.L.P. Km. 57.8
C.P. 37980 San José Iturbide,
Guanajuato México

** Our Mexico location is a joint
venture between JM Eagle™ and
Plastics Technology*

GLOBAL HEADQUARTERS

5200 West Century Boulevard
Los Angeles, California 90045

REGIONAL OFFICE

Nine Peach Tree Hill Road
Livingston, New Jersey 07039

J-M Manufacturing Co., Inc. and PW Eagle, Inc. are doing business as JM Eagle™.

JM Eagle

- THE LEADER IN PIPE INNOVATION
- THE HIGHEST LEVEL OF QUALITY
- THE LARGEST BREADTH OF PRODUCT
- THE WIDEST CAPACITY
- EXPRESS DELIVERY

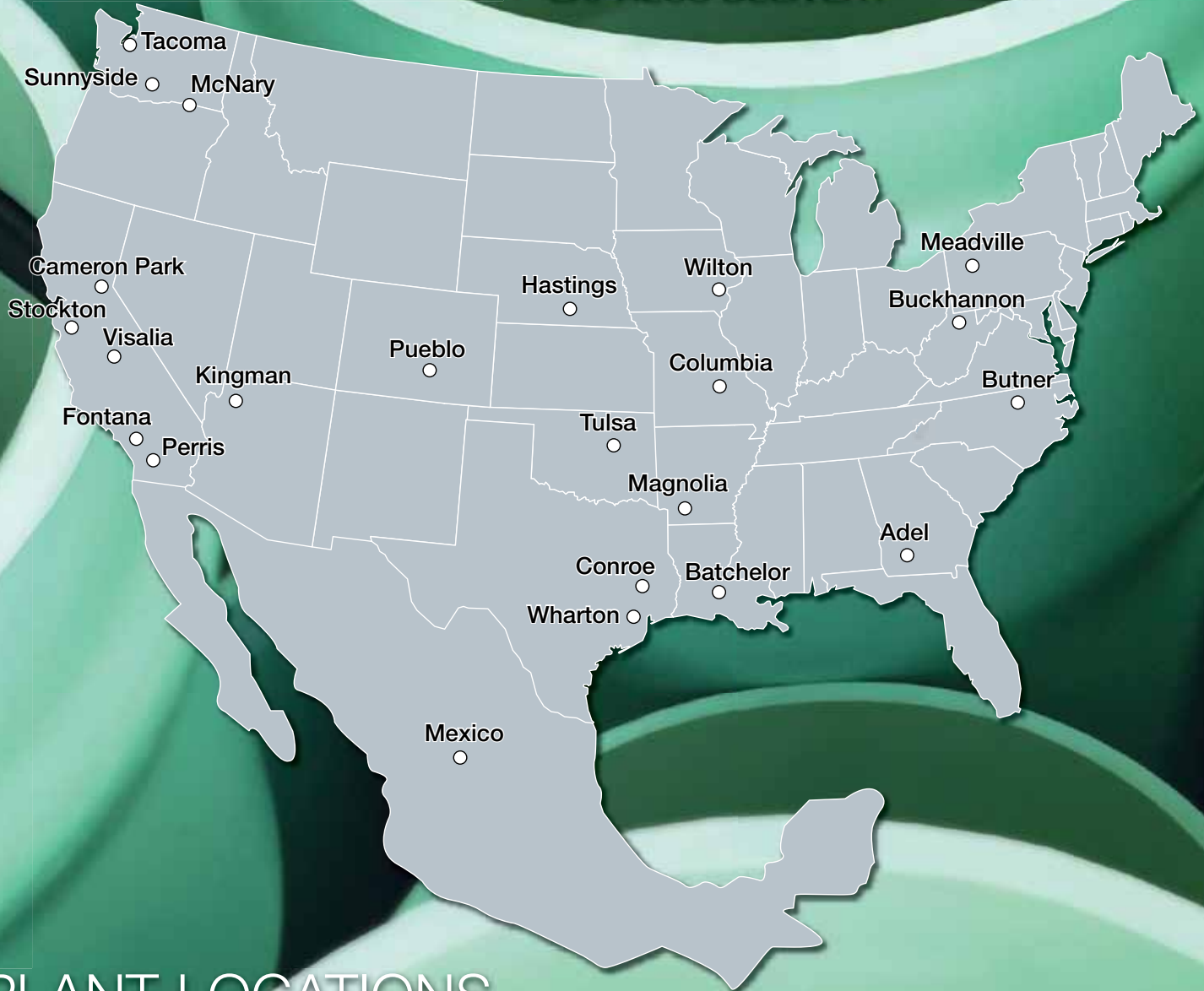

PLANT LOCATIONS

Revised January 2009
JME-05A
© J-M Manufacturing Co., Inc.



*Building essentials
for a better tomorrow™*

GLOBAL HEADQUARTERS:

5200 West Century Blvd
Los Angeles, CA 90045
T: 800.621.4404
F: 800.451.4170

www.JMEagle.com

REGIONAL OFFICE:

Nine Peach Tree Hill Road
Livingston, NJ 07039
T: 973.535.1633
F: 973.533.4185